

KICKASS



12V BATTERY MONITOR WITH 500A SHUNT

OWNER'S MANUAL

TABLE OF CONTENTS

WHY KICKASS?	1
OVERVIEW	1
WARNINGS	1
INCLUDED PARTS	2
OPTIONAL ACCESSORIES	2
PRODUCT OVERVIEW	3
SPECIFICATIONS	3
INSTALLATION	4
SETUP	6
OPERATION	7
TROUBLESHOOTING	8
WARRANTY DISCLAIMER	9

CONGRATULATIONS ON PURCHASING YOUR NEW KICKASS 12V BATTERY MONITOR WITH 500A SHUNT

WHY KICKASS?

KickAss is focussed on bringing the luxury of home to the outdoors. Your one stop shop for 12V products. All of our products are designed to be plug and play for the ultimate camping experience.

OVERVIEW

The KickAss Battery Monitor with 500A Shunt includes the following features:

- Battery State of Charge (SOC %).
- Instantaneous current (A) flow, positive when charging, negative when discharging
- Battery voltage
- Ambient temperature
- Remaining time to full/empty calculations
- Low battery / Low SOC alarm - Audible alarm can be muted
- Remote Display with back lit LCD screen

WARNINGS

- Please read and understand the product user manual and warnings carefully before installing and operating.
- Any 12V installation work should be done by a professional, failing to do this may result in damage to your unit or vehicle.
- Ensure suitable gauge wiring is used.
- It is the customers responsibility to ensure that all components are safely and correctly installed.
- Disassembling the device may void warranty.
- Do not expose the display to excessive moisture or dust.
- Do not expose the display screen to excessive sunlight, doing so may shorten the lifespan of the LCD.

INCLUDED PARTS



Battery Monitor Display

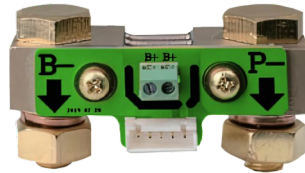

500A Shunt with M8 Bolts



Shunt Holder



B+ Wire (Shunt power and voltage sensing)



Shunt Data and Power Cable



1m Battery Temperature Sensor



Mounting Screws

OPTIONAL ACCESSORIES



5m extension cable

KA recommends using the 5M (RDU) extension cable to remotely mount your Battery Monitor Display.

SKU: KARDUEXT5M

PRODUCT OVERVIEW

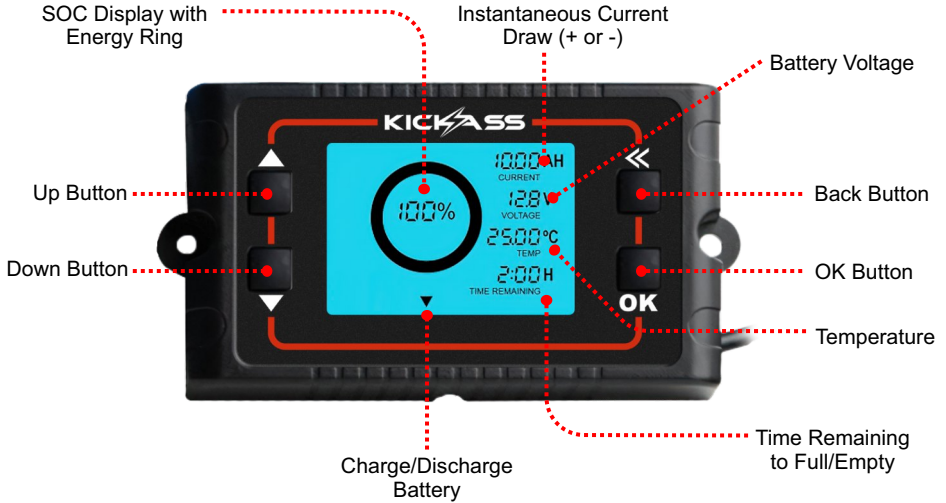

SPECIFICATIONS

Description	Parameter
Working Voltage Range	10-30V DC
Working current (backlight on)	~100 mA
Standby current (backlight off)	~1-2 mA
Accuracy	1%
Battery Capacity Range	0.1 - 999.9Ah
Operating Temperature Range	-10° to 60°
Display Housing Dimensions	126L x 66.6H
B+ Wire	20AWG, Length: 100mm
Display Temperature Sensor Cable	900mm
Display Data Cable	25cm
Shunt Assembly Data Cable	35cm
Optional extension cable wire length	Recommended 5m Extension Cable

INSTALLATION

Fitting Shunt Assembly

The shunt can be connected to a battery in two ways, bolted directly to the negative battery terminal or connected via a short wire to the negative terminal.

Option 1 - Direct to Battery

1. To bolt the shunt directly to the battery terminal, remove the bolts from the shunt assembly and discard the shunt holder.
2. Using the included M8 bolt, washers and nut, attach the shunt side labeled "B-" to the negative battery terminal.
3. Fit the B+ Wire by inserting the exposed conductor end into the small green terminal block located on the shunt. This is labeled B+. Tighten down the terminal block screw with a 2.4mm flat head screw driver.
4. Now fit the ring terminal to the battery positive pole, along with the system positive loads.

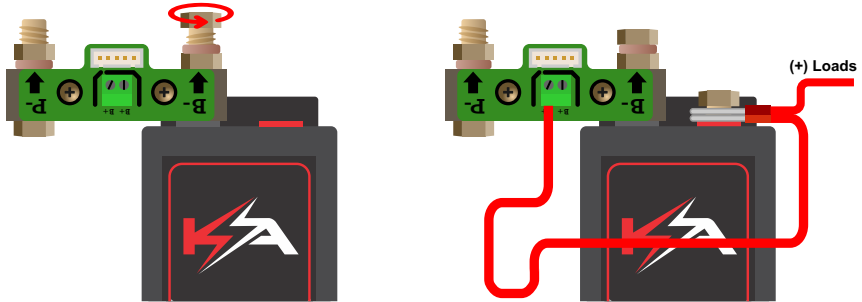

Option 2 - Fit shunt assembly using holder

1. The shunt can be mounted to a flat surface using any of the pre drilled holes in the shunt holder.
2. Connect a cable assembly using M8 ring terminals and a minimum of 25mmsq wire, to the shunt side labeled "B-". The cable assembly should be maximum of 300mm long. Connect the other side of the cable assembly to the battery Negative terminal.
3. Follow steps 3 and 4 as above.

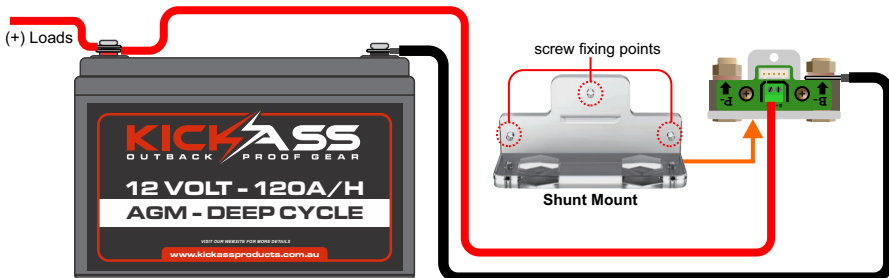

CAUTION:

- Please check all connections are correctly terminated and secured tightly!
- Ensure the B+ Wire is fitted using circuit protection: Split conduit or an in-line fuse rated at 3A will be suitable.

INSTALLATION

Connecting Display to the Shunt Assembly

The Battery Monitor Display can be connected to the Shunt, with the provided cables. To do this firstly connect the data cable to the shunt assembly by plugging in the small white 5 pin connector, now connect the two round black connectors to join the display and shunt together. The Temperature sensors can now be run to the battery or desired location for ambient temperature reading.

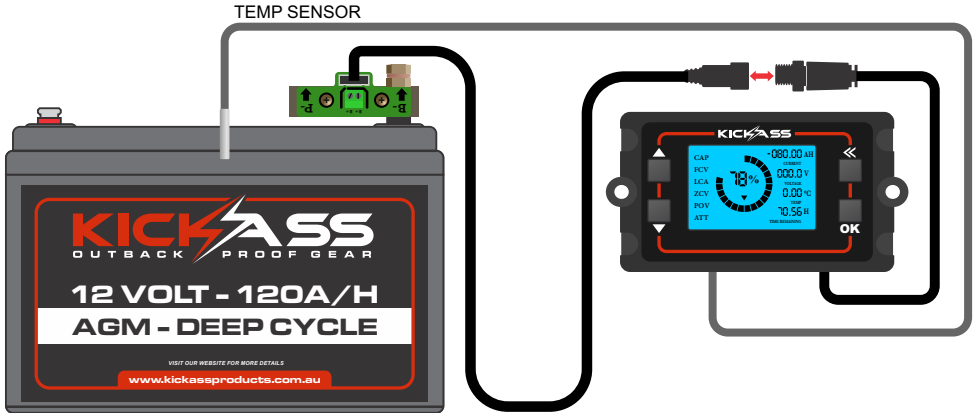

Connecting Loads and Chargers to Shunt Assembly

When connecting loads and chargers to the battery using the Shunt, system negative connections must be connected to the P- side of the Shunt Assembly. No negative connections should be made directly to the battery terminal as this will cause the battery monitor to provide false readings. When wiring batteries in parallel, ensure the correct connection configuration is used. Please refer to diagram.

CAUTION: Use a suitably rated Fuse/Circuit breaker for all loads. When using the shunt in the parallel configuration, we recommend using an in line fuse for the B+ Wire. See diagram.

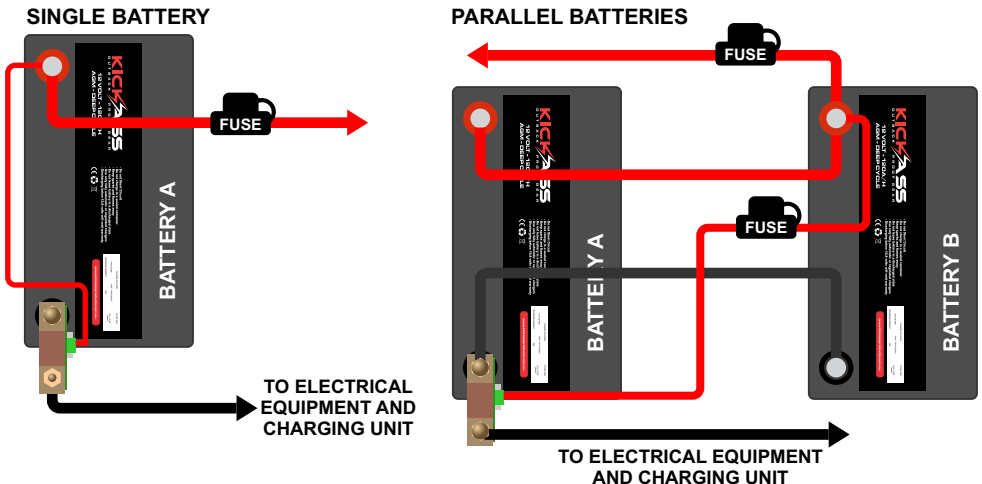

SETUP

Initial Setup

Before powering any system loads, the display must be calibrated to 100% SOC. Do this by ensuring your battery bank is fully charged and the display is showing 100%. To manually calibrate the SOC, press and hold the UP arrow for 3 seconds.

NOTE: The connected battery charger should be in the float stage before manually calibrating the display.



Setting Parameters

To access the parameter setting menu, press and hold the OK button for approximately 3 seconds.

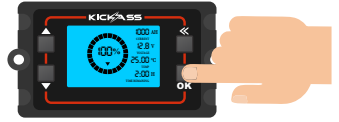

The following screen will be displayed. The selected line will begin to flash, to navigate through each line use the up and down arrows. Click OK to select the parameter and then using the up and down arrows, set the values. Use the OK button to move the cursor to the left. The Back (<<) button can be used to exit out of the selected parameter and used again to close the settings menu.

- Battery Capacity (Ah) → CAP
- Full Cell Voltage (V) → FCV
- Low Capacity Alarm (Ah) → LCA
- Zero Cell Voltage (V) → ZCV
- Power Off Voltage (V) → POV

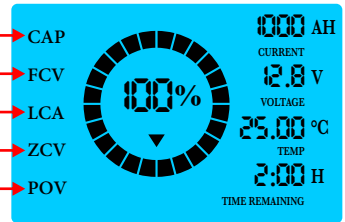

Each of the following parameters will need to be set, below is a table which shows typical values for different battery types:

CAP - Battery Capacity: The total capacity of the battery bank is measured in Ah and is the total capacity of your battery bank. For example: 2x 120AH batteries connected in parallel will total 240Ah.

FCV - Full Cell Voltage: This parameter setting is the voltage point at which the battery is fully charged. When this voltage point is reached, the displayed SOC will calibrate to 100%. The system has now calculate that the battery bank is fully charged. It is recommended to set this value to the max charge voltage of your battery charger. Please check the manufactures specifications. NOTE: If calibration is off, see trouble shooting guide for details.

LCA - Low Capacity Alarm: An audible alarm will sound when the remaining capacity is below this set value and the current (A) value will flash on the display. For lead acid batteries like AGM, it is recommend to set this value equal to or above the recommend usable capacity (50% of the total CAP). For example, a 120Ah AGM battery should be set to 60Ah or above.

ZCV - Zero Cell Voltage: The zero cell voltage is the value point at which the battery bank is empty. Once this value has been reached, the SOC% will automatically reset to 0% and voltage display will flash. The audible alarm will also sound once per 10s if the load discharge the continues.

NOTE: This value should be set just above the recommended minimum operating voltage of your battery type. For example, Lithium: 10~10.4V, AGM: 10.5~10.9V

POV - Power Off Voltage: The power off voltage is the value point at which the display screen will turn off to save power. This will occur after 10s once the battery voltage is below this set value. To wake the screen up, press the OK button.

Recommended Values for Different Battery Types

Battery Type	GEL	AGM	WET	CALCIUM	LITHIUM
CAP	*Total rated capacity of battery bank. For example: A single @ 120Ah battery: CAP= 120Ah, 2x battery @ 120Ah: CAP= 240AH				
FCV (refer to charger spec)	14.1V	14.4-14.7V	14.7V	14.7V	14.4-14.6V
LCA	50%-60% of CAP				20%
ZCV	10.8V				10.5V
POV	11.5V				12V

* Rated Capacity - The capacity the battery is rated to by the manufacturer. For many battery types like AGM, it is not recommended to use 100% of the battery capacity.

** DOD: Depth of Discharge - The percentage at which the battery is discharged in relation to the rated capacity. eg. At 80% DOD, the State of Charge is approximately 20% of the total rated capacity of the battery.

** ATT Setting

Early versions of the KickAss Battery Monitor with 500A Shunt utilised an ATT value. If the ATT value is present in the configuration menu, please ensure this value is set to 0.

OPERATION

Backlight

The LCD is fitted with a Backlight. To turn on the Backlight, press the OK button. The Backlight will time out and turn off after 60 seconds.

Alarm

The alarm will sound when the capacity of the battery goes below the set value. This alarm can be muted by pressing the OK button.

Power off voltage

If the battery falls below the user set power off voltage (POV), the display will turn off within 10 seconds. To view the display, press the OK button, the display will turn off again after 10 seconds of inactivity.

SOC% Calibration

Manual Calibration is necessary on initial setup and after some time of use, if the SOC% does not reach 100% under normal operation. To do this simply fully charge your battery and hold the UP arrow for 3 seconds. If the display is frequently getting out of calibration, the user defined setting may require review.

TROUBLESHOOTING

Q: Battery is discharging but the display is showing it is charging or vice versa.

A: It is likely the Shunt is wired back to front. Ensure the negative battery terminal is connected to the B- side of the shunt and loadschargers are connected to the P- side of the shunt.

Q: The display is not turning on.

A: Check to see all connection between display and shunt are fully connected, ensure dongle connection is screwed together.

A: Check to ensure that the red wire is connected to the positive terminal of the battery and to one of the two B+ points on the Shunt.

A: Press the OK button, if the display turns on than turns off again, it is likely the battery voltage is below the POV setting.

Q: The Displayed SOC% is not accurate. This could occur if the display shows 0% SOC before the system is at the correct DOD or the calibrating to 100% SOC is not occurring at the expected time. For example, too early or not at all.

A: Check the CAP setting, this may need to be adjusted for the type of battery.

Review the FCV - The setting value for the max charging voltage may need to be reduced (100% not reached once charger is in float stage) or increased (100% reached before the charger has reached float stage).

Check ZCV - If 0% is reached too soon, this value needs to be increased and vice versa.

Q: What is the maximum current the shunt can monitor?

A: The shunt is rated to 500A continuous draw.

KICKASS PRODUCTS PTY LTD. WARRANTY DISCLAIMER

At Kickass Products Pty Ltd., we stand behind the quality and durability of our outdoor and camping products. Our product team rigorously tests every item in demanding conditions to ensure performance in normal use environments.

Limited Warranty Coverage

Kickass Products Pty Ltd. warrants that our products are free from manufacturing defects in materials and workmanship for the applicable warranty period. If a defect arises within this period, we will, at our discretion, repair, replace, or provide an appropriate remedy in accordance with Australian Consumer Law (ACL).

Exclusions

Warranty does not cover:

- Normal wear and tear
- Misuse, abuse or improper installation
- Damage caused by accidents, modifications, or lack of proper maintenance
- Consumable parts, unless a defect in materials or workmanship is present

Making a Warranty Claim

To initiate a claim, please retain your proof of purchase and contact our customer service team with details of the defect. We will guide you through the process, including potential return or assessment requirements.

Your Rights Under Australian Consumer Law

This warranty is in addition to any rights or remedies you may have under the ACL and does not exclude, restrict, or modify them.

Thank you for choosing Kickass Products Pty Ltd. We are committed to ensuring your outdoor adventures are backed with confidence.

KICKASS

**KickAss is a registered trademark of
KickAss Products Pty Ltd.**

**Designed & imported by
KickAss Products Pty Ltd
39 Iris Place, Acacia Ridge, QLD 4110
Australia**

Made in China