

**KICKASS**

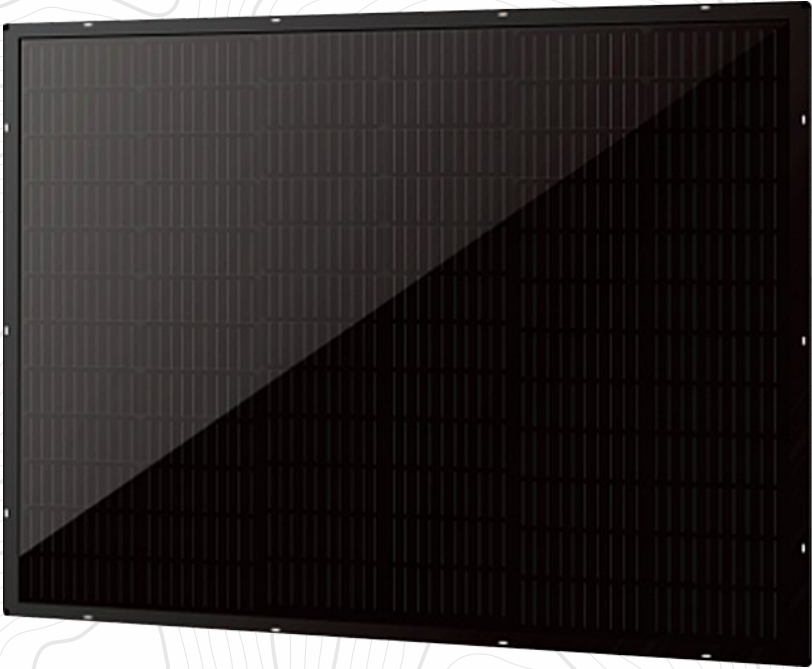

**ULTRA SLIM FIXED  
GLASS SOLAR PANEL**

**OWNER'S MANUAL**

KAUSSP80 | KAUSSP110 | KAUSSP170 | KAUSSP210 | KAUSSP280

# TABLE OF CONTENTS

SAFETY INFORMATION -----	1
PRODUCT SPECIFICATIONS -----	3
PRODUCT OVERVIEW -----	6
INCLUDED COMPONENTS -----	7
PRODUCT INSTALLATION -----	8
USING YOUR SOLAR PANEL -----	12
CHOOSING A SUITABLE REGULATOR -----	12
CONNECTING THE SOLAR PANEL -----	12
WARRANTY & SUPPORT INFORMATION -----	13

# SAFETY INFORMATION

**SAVE THESE INSTRUCTIONS - This manual contains important instructions that shall be followed during installation and maintenance.**



**Danger of explosion from sparking**

**Danger of electric shock**

WARNING

**WARNING: DC (PV) INPUT NOT ISOLATED, NEVER TOUCH UNISULATED CABLE ENDS.**

- Please read this manual carefully before the product is installed and put into use.
- This product is not intended for use by children. It should also not be used by adults with reduced physical or mental capabilities or individuals under the influence of drugs or alcohol.
- This product is designed and tested in accordance with international standards. The equipment should be used for the designated application only.
- Connections must always be made in the sequence described under the product Installation.
- Always keep the solar panel away from liquids.
- The installer of the product must provide a means for cable strain relief to prevent the transmission of stress to the connections
- Never touch uninsulated cable ends.
- Use only insulated tools.
- This is an unregulated solar panel. Always connect it to a suitable charge regulator (sold separately) to prevent overcharging and protect the battery from damage.
- DO NOT USE the solar panel or its wiring if it is damaged or compromised in any way. Regularly inspect the unit for any signs of wear or damage.
- When mounting the solar panel, only use the pre-drilled holes. Do not drill additional holes into the frame as it could damage the panel or void the warranty.

- The individual KAUSSP80, KAUSSP110, KAUSSP170, KAUSSP210, and KAUSSP280 solar panels are designed specifically for charging 12V rechargeable batteries. Do not use it for other purposes.
- Tampering with or modifying the solar panel or its wiring will void the warranty.
- Always securely fasten the solar panel during transportation to prevent movement or collision with other objects.
- Be cautious when maneuvering and setting up the solar panel to avoid damaging the unit.
- Do NOT connect the Solar Panels directly to a battery. Always use a solar regulator of the correct input rating to connect the Solar Panels before connecting and charging the battery.
- Ensure to use the Solar Panel with a regulator of the correct input rating and suitable charge profile for the battery chemistry type being charged.
- To reduce the risk of sparks, connect or disconnect the Solar Panel to the charge regulator before exposure to sunlight. The Solar Panels may generate voltage up to the rated open circuit voltage value at the connection leads while unconnected.
- The Solar Panel will achieve the best results when proper battery maintenance is regularly performed.
- Do not use mirrors or other devices to artificially concentrate sunlight on the Solar Panel.
- All panels used in series, parallel, or series-parallel are suggested to be the same model. Check the manufacturer data for the regulator you select and ensure that the open circuit voltage does not exceed the recommended maximum charging voltage and that the cable you select can handle the high current and voltage.
- Partially shaded or partially obscured Solar Panel will have a reduced output and can potentially damage the Solar Panel over time.

# PRODUCT SPECIFICATIONS

## KAUSSP80

Cell type	Mono PERC
Max power (Pmax)	80W
Open circuit voltage (Voc)	25.07V
Short circuit current (Isc)	4.35A
Front Glass	2mm Tempered glass
Frame	Anodized aluminum alloy
Dimensions	635 x 795 x 5.9mm
Weight	3.6kg
Maximum system voltage	1500VDC
Maximum series fuse rating	10A
Operation temperature	-40°C - 85°C
Nominal operation cell temperature	42
Module Efficiency	15.8%

## KAUSSP110

Cell type	Mono PERC
Max power (Pmax)	110W
Open circuit voltage (Voc)	20.96V
Short circuit current (Isc)	6.72A
Front Glass	2mm Tempered glass
Frame	Anodized aluminium alloy
Dimensions	990 x 600 x 5.9mm
Weight	4.2kg
Maximum system voltage	1500VDC
Maximum series fuse rating	15A
Operation temperature	-40°C - 85°C
Nominal operation cell temperature	42
Module Efficiency	18.5%

## KAUSSP170

Cell type	Mono PERC
Max power (Pmax)	170W
Open circuit voltage (Voc)	24.62V
Short circuit current (Isc)	8.78A
Front Glass	2mm Tempered glass
Frame	Anodized aluminium alloy
Dimensions	830 x 1155 x 5.9mm
Weight	6.7kg
Maximum system voltage	1500VDC
Maximum series fuse rating	15A
Operation temperature	-40°C - 85°C
Nominal operation cell temperature	42
Module Efficiency	17.7%

## KAUSSP210

Cell type	Mono PERC
Max power (Pmax)	210W
Open circuit voltage (Voc)	53.04V
Short circuit current (Isc)	5.01A
Front Glass	2mm Tempered glass
Frame	Anodized aluminium alloy
Dimensions	980 x 1155 x 5.9mm
Weight	8kg
Maximum system voltage	1500VDC
Maximum series fuse rating	10A
Operation temperature	-40°C - 85°C
Nominal operation cell temperature	42
Module Efficiency	18.6%

**KAUSSP280**

Cell type	Mono PERC
Max power (Pmax)	280W
Open circuit voltage (Voc)	44.88V
Short circuit current (Isc)	7.87A
Front Glass	3.2mm Tempered glass
Frame	Anodized aluminium alloy
Dimensions	1275 x 1134 x 35mm
Weight	16kg
Maximum system voltage	1500VDC
Maximum series fuse rating	15A
Operation temperature	-40°C - 85°C
Nominal operation cell temperature	42
Module Efficiency	19.4%

# PRODUCT OVERVIEW

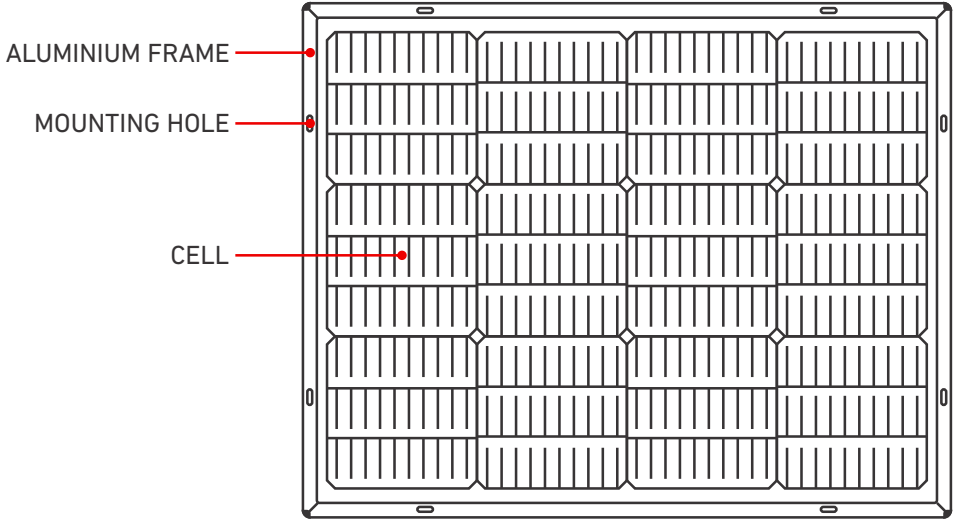

**FRONT VIEW**

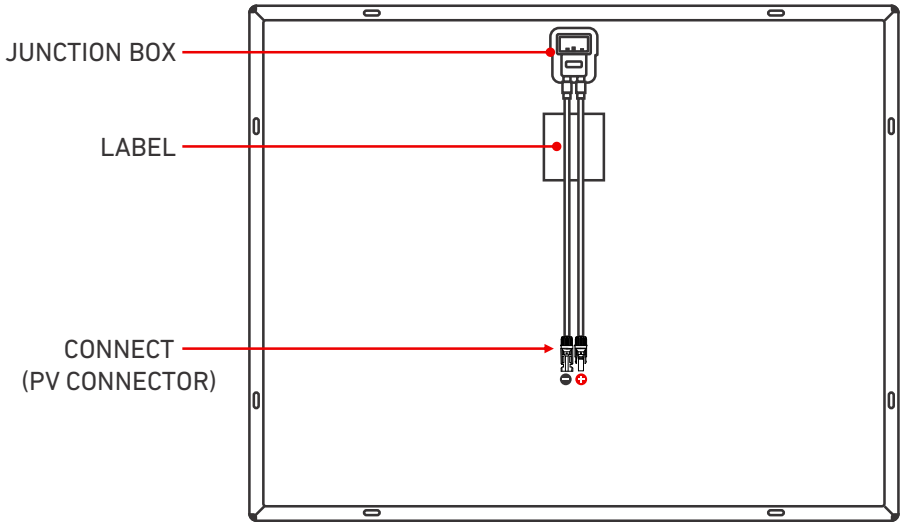

**BACK VIEW**

# INCLUDED COMPONENTS

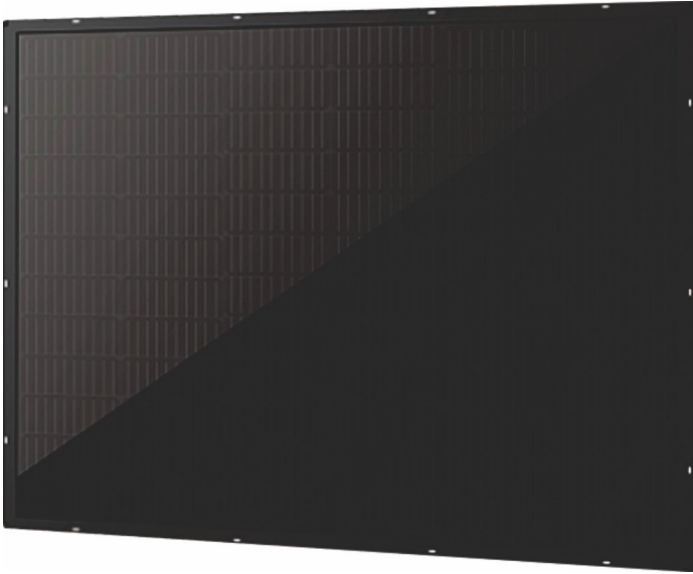

1 X SOLAR PANEL

## OPTIONAL MOUNTING KIT SOLD SEPARATELY (KAUSSPMK)



4 X ALUMINUM Z SHAPED BRACKET



4 X M4 SS 306  
SELF-LOCKING NUT

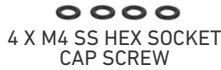

4 X M4 SS HEX SOCKET  
CAP SCREW



4 X SS 306 WASHER



4 X M4 SS HEX  
SOCKET CAP SCREW



8 X SS306 HEX HEAD  
SELF-DRILLING  
TAPPING SCREW

# PRODUCT INSTALLATION

## Step one

Remove the solar panel from the box packaging

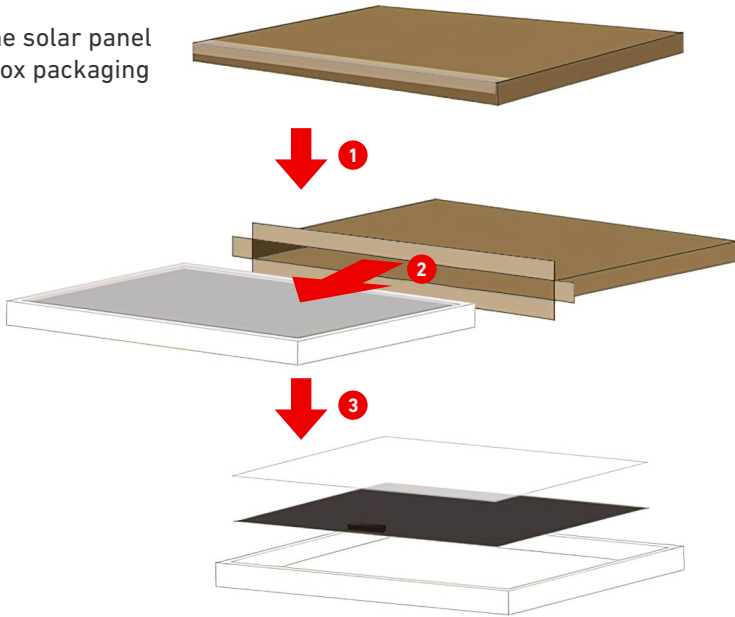

## Step two

Remove dust from panels: Although our solar panels come with protective packaging, we recommend gently wiping off any dust that may have accumulated during shipping before installation. Use a soft, dry cloth to ensure the panels are clean and ready for optimal performance.

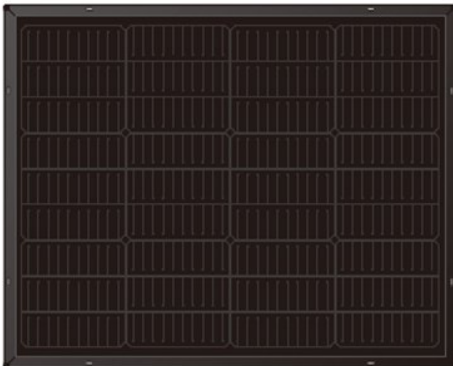

### Step three

Installing the Z shaped brackets onto the solar panel.

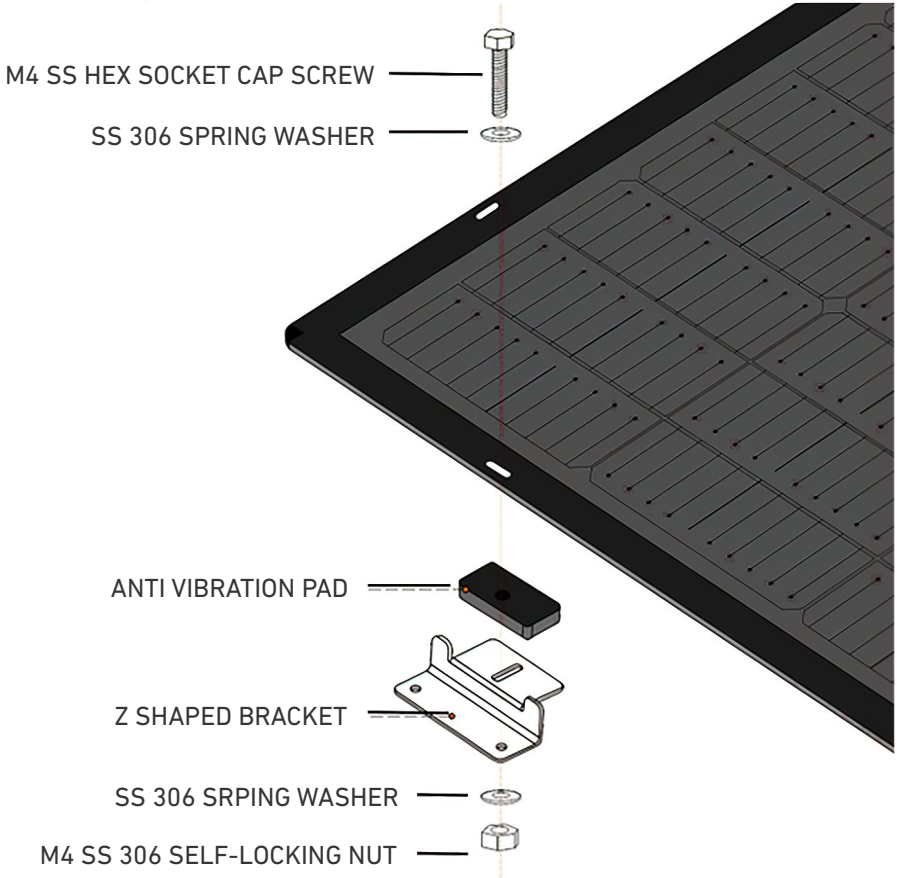

Repeat for each of the four Z shaped brackets.

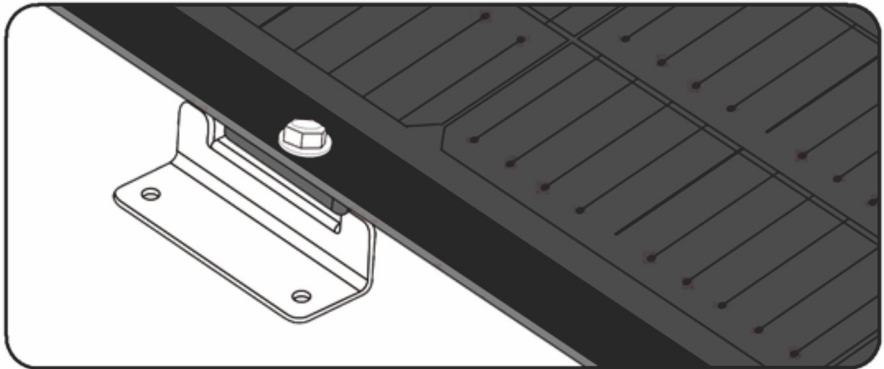
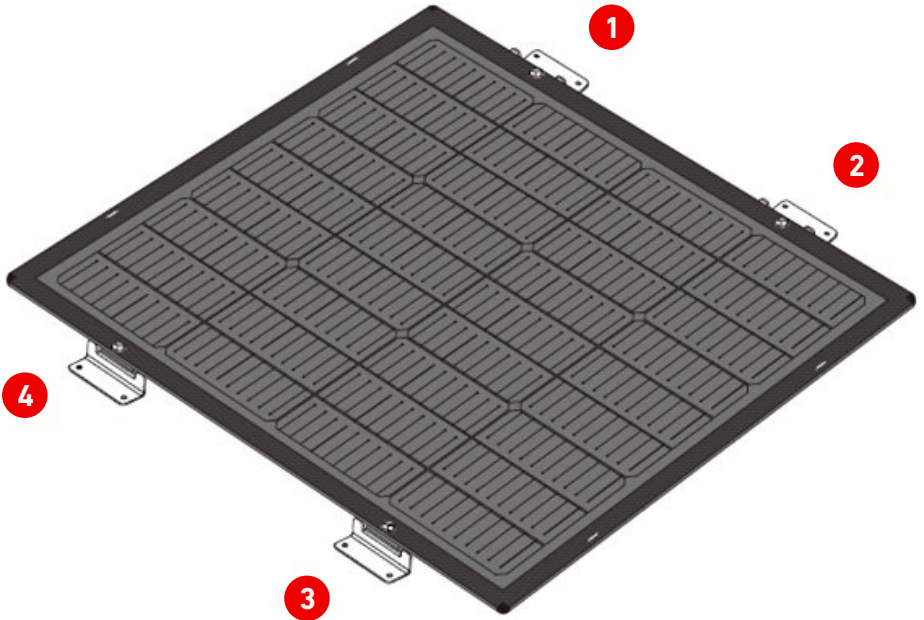

Installing the solar panel to the general mounting surface using 8 x SS306 hex head self-drilling tapping screw.

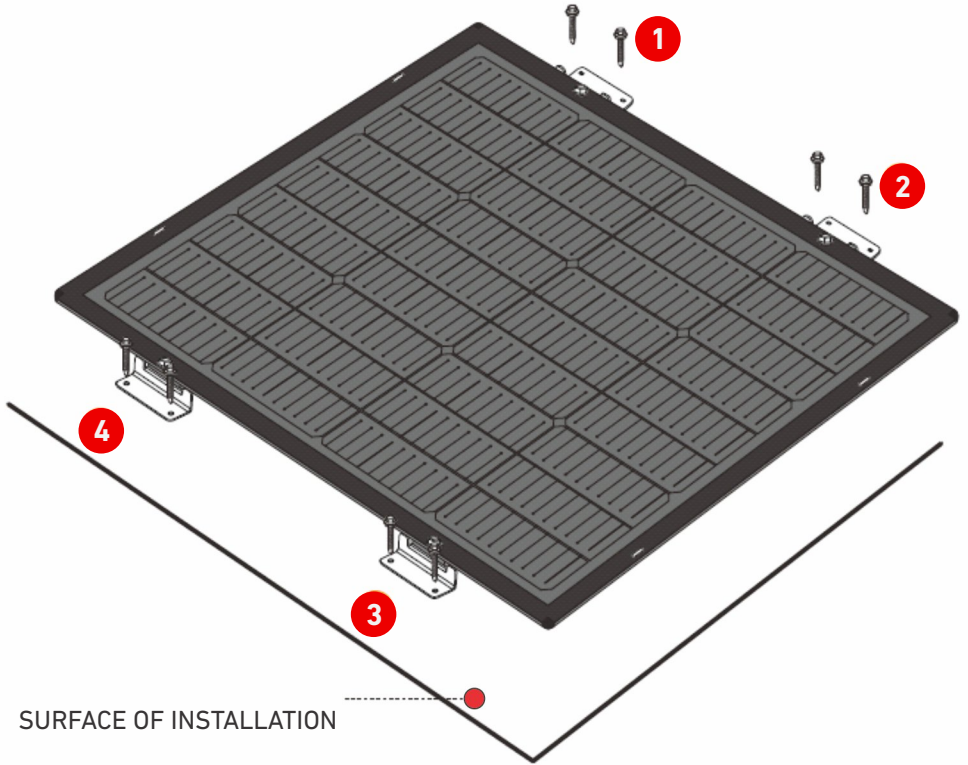

# USING YOUR SOLAR PANEL

## CHOOSING A SUITABLE REGULATOR

**Warning:** This is an unregulated solar panel - ensure you connect a suitable regulator (available separately) to prevent damage to the battery

- These panels are compatible with PWM and MPPT regulators and can be used on the solar input of DC-DC Chargers.
- Ensure the regulator or DC-DC Charger has an input voltage limit higher than the Open Circuit Voltage (VOC) of the panel
- Ensure the regulator or DC-DC Charger has an input current limit higher than the Short Circuit Current (ISC) of the panel
- Ensure the regulator or DC-DC Charger has an input power limit higher than the power rating of the panel
- Ensure the regulator or DC-DC Charger is suitable for the battery type you are charging (AGM, GEL, LiFePO4 etc.)

## CONNECTING THE SOLAR PANEL

- Ensure you're using a suitable solar regulator to charge your battery - do not connect the solar panel directly to a battery.
- First connect the regulator as close as possible to the battery, then connect the regulator to the solar panel using the PV connectors - if more length is required between the solar panel and solar regulator, use a PV extension cable.

## WARRANTY & SUPPORT INFORMATION

Need help? For product support or to make a warranty claim, reach out to the KickAss Customer Service team on: [warranty@kickassproducts.com.au](mailto:warranty@kickassproducts.com.au)

Alternatively, visit our Customer Support Portal at:  
<https://supportportal.kickassproducts.com.au/>

# KICKASS

**KickAss is a registered trademark of  
KickAss Products Pty Ltd**

**Designed & imported by  
KickAss Products Pty Ltd  
39 Iris Place, Acacia Ridge, QLD 4110  
Australia**

**Made in China**

