

# For comfortable cooling

Truma air conditioning systems

Valid from  
January 2021

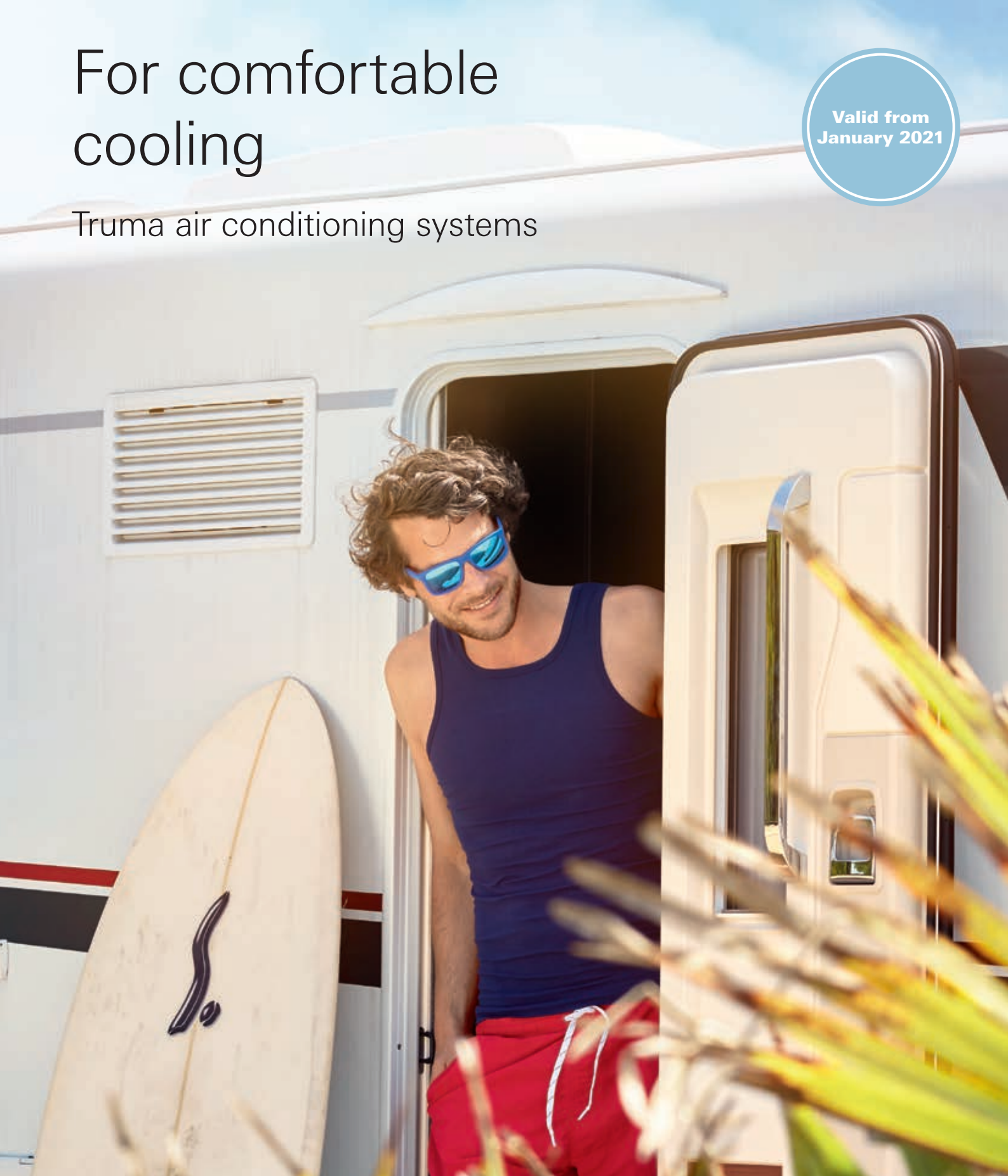

heating | cooling | controlling

More comfort on the move



### Stay cool – even on hot days

Surfing, playing beach volleyball or simply relaxing on the beach: Many campers head south in summer. To cool down after sporting activities, nothing beats a refreshing dip in the ocean. And in the evening you can return to just the right temperature in your caravan or motor home – thanks to the well-engineered air conditioning systems by Truma. Why not try them for yourself?

# Contents

4	Truma – The company
6	Customised climate comfort
<b>Truma iNet System</b>	
8	Intelligent device control
10	Truma CP plus and Truma iNet Box
<b>Air conditioning systems</b>	
12	Truma Aventa roof-mounted air conditioning system
12	Truma Aventa comfort
13	Truma Aventa compact
13	Truma Aventa compact plus
14	Truma Saphir storage box air conditioning systems
17	Truma Saphir compact
17	Truma Saphir comfort RC
<b>Truma Online and Service</b>	
19	Online, Service and Truma Partners



Subject to change; no liability for errors.  
The same applies to illustrations.

# Our roots are in caravanning

Heading to the future with you.

Truma has been the leading specialist for caravan accessories for more than 70 years. We set standards from the very beginnings of our company history and we will continue to do so. For example, in 1961 we pioneered caravan heating without which winter camping would not be possible. Today, we are market leaders in this area – and, for some time, it has also been possible to control Truma heaters with an app. Our prime objective has always been to make sure that campers have the best possible holiday experience. So that we will also be able to do this in the future, we are constantly looking for the best ideas.



## Reliability

- Family company in the third generation – independent and autonomous.
- Well thought out products and services.
- High-quality equipment that seldom requires repairs.

## Competence

- Many years of expertise developed over generations.
- Many innovative product ideas that move tomorrow's market.
- Smart, future-oriented, holistic development.

## Quality

- Highest demands in the entire supply chain.
- Zero-defect manufacturing at the production location in Germany.
- Automated check of all products for many different parameters.

## Service

- Technically competent, fast and friendly help.
- Personal phone support in eleven languages.
- Top service with 500 partners in more than 30 countries.

See our website for an insight into Truma's history:



[www.truma.com/history](http://www.truma.com/history)

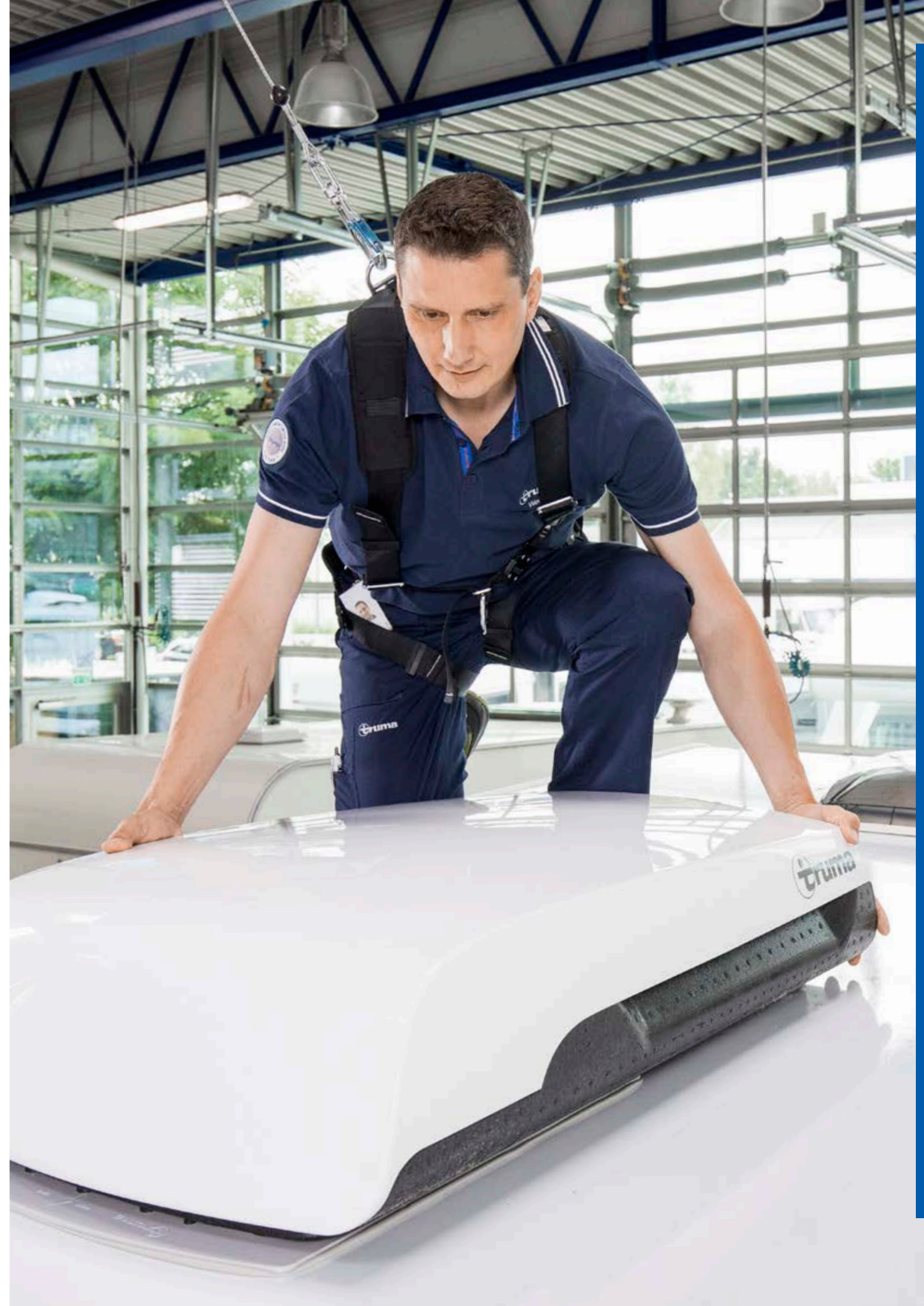

# Customised climate comfort

Whether roof or storage box – Truma has high-quality air conditioning systems for both. All devices are based on our many years of air conditioning experience and stand out due to their excellent cooling comfort. The air is cooled particularly efficiently and is also reliably dehumidified.

The required cooling performance – to make sure you choose the right air conditioner – depends on the following factors:

- Size of the interior
- Temperature and humidity
- Vehicle shading

Long vehicles in particular are best cooled with two Truma air conditioning systems, meaning that roof-mounted and storage box systems can be combined.

## Get the expert tips!

We've put together lots of useful information for you about climate comfort in motor homes and caravans. Our air conditioning guide will help you decide which air conditioning system is right for you, what to look out for when buying one and how the Truma air conditioning systems measure up against the competition.



Download now at [www.truma.com/air-conditioner-guide](http://www.truma.com/air-conditioner-guide)

## The ideal air conditioning system for every vehicle

### Truma Saphir storage box system

The Truma Saphir air conditioning system is installed in the storage space of the caravan. It distributes the air individually and flexibly in the room. It also shifts the centre of gravity to the bottom of the caravan, which has a favourable effect on driving quality.

### Truma Aventa roof-mounted air conditioning system

To save space, an Aventa air conditioning system is installed on the roof of the caravan, motor home or van, such as instead of a skylight. The air distributor inside the vehicle is especially flat – so as not to cause any obstruction.



Truma Saphir compact

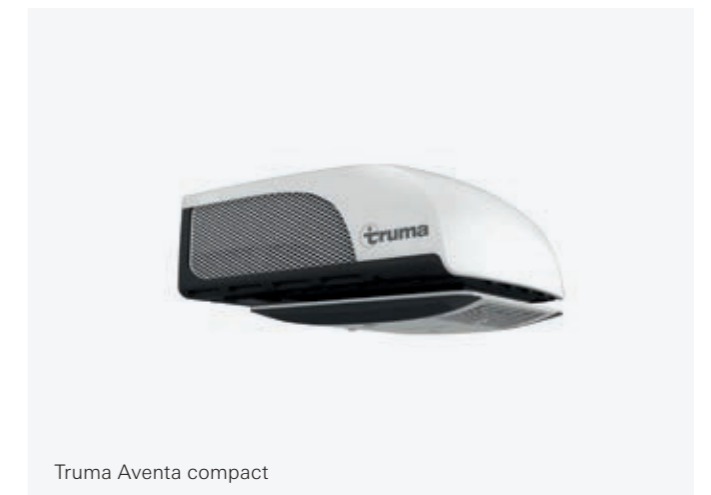

Truma Aventa compact

### Aventa roof-mounted air conditioning system

Aventa compact

Aventa compact plus

Aventa comfort

### Saphir storage box system

Saphir compact

Saphir comfort RC



Living area to be cooled with a vehicle length of approx.

# Smart appliance control, maximum comfort

## Truma iNet System: everything under control

It couldn't be easier: while you're sitting comfortably in your lounge, simply take out your smartphone and check how much gas there is in the cylinder before you go to bed. With the Truma iNet System, that's all there is to it! And with the Truma App, you can do more too: besides checking exactly how much gas you have left, you can also easily control your air conditioning and heater – anywhere, any time.

### The Truma iNet System consists of the following:

- The **Truma iNet Box** as the system's core.
- **iNet-capable appliances** such as Truma LevelControl, various heaters and air conditioning systems.
- The free **Truma App** on your smartphone or tablet.

### How the Truma iNet System works

The **Truma iNet Box** is the central control unit that links **Truma LevelControl**, the **heater** and **air conditioning** with your smartphone or tablet. The system operates via Bluetooth when you're in range and

SMS if you're out and about. With the Truma App you can control your heating and air conditioning systems and conveniently check how much gas there is in the cylinder. For this you need the Truma LevelControl, which can simply be incorporated into the iNet system. It uses ultrasound to precisely measure how much gas there is in your cylinder and indicates how much longer the gas will last.

### The Truma App

The Truma App is packed with helpful features and useful camping tools. Download the free Truma App on your smartphone or tablet.



[www.truma.com/inet](http://www.truma.com/inet)

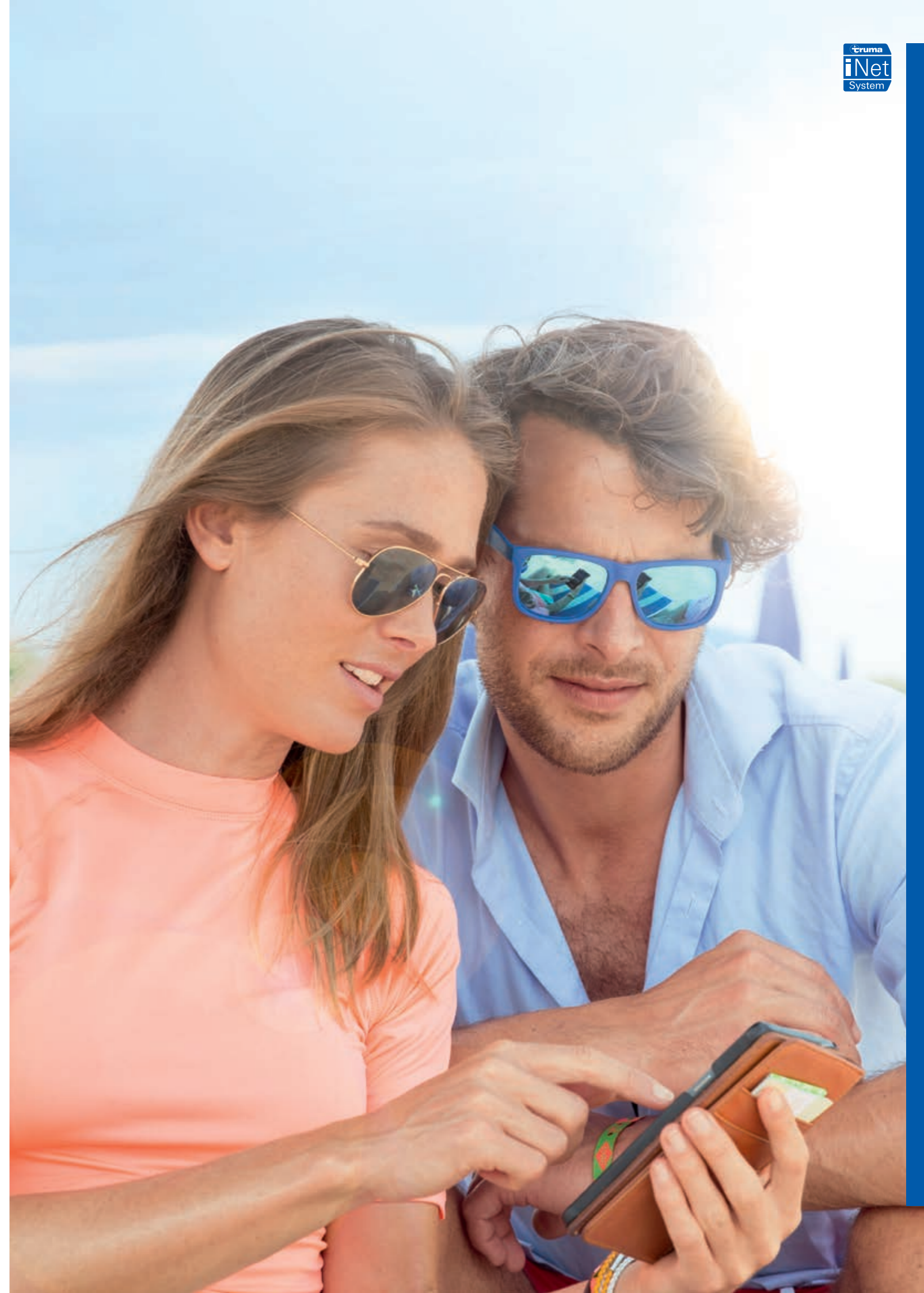

# For the ultimate feel-good climate

Also available as  
Truma iNet Set

## Truma CP plus and Truma iNet Box

### Truma CP plus

Control your iNet-capable heater and air conditioning system with the digital Truma CP plus control panel. Choose the type of energy, adjust the fan or set the functions of your heater or air conditioning system with the time switch.

### Truma iNet Box

The Truma iNet Box is the intelligent interface that allows you to control your iNet-capable devices conveniently from your smartphone via SMS while you are on the move – or via Bluetooth if you are within range. For example, to control the temperature

in your vehicle, all you need is the free Truma App. The Truma iNet Box is easy to install and can be retrofitted for all iNet-capable heaters and air conditioning systems.

### Truma automatic climate control

No matter what the temperature is outside: automatic climate control keeps your vehicle at the desired temperature. It coordinates the air conditioning system and heater to keep your vehicle at the perfect temperature. You can use either the CP plus control panel or the Truma App to regulate your automatic climate control.



## Truma CP plus

### Digital control panel for heaters and air conditioning systems

The digital Truma CP plus control panel allows you to set the temperature in your vehicle quickly and easily. Choose functions like fan speeds and night time economy mode instantly. The automatic climate control ensures a constant indoor temperature in all weathers.



- **Intuitive operation:** With practical rotary pushbutton and large backlit display.
- **Booster function:** Heats water and your vehicle's living area very quickly.
- **Time switch:** The perfect water and room temperature set in advance at all times.

### Technical data

- Power supply: 8 – 16.5 V
- Power consumption: max. 65 mA (100% background lighting), 6.5 – 10 mA (standby)
- Quiescent current consumption: 3 mA (Off)
- Dimensions: 92 x 103 x 40 mm (L x W x H)
- Weight: approx. 100 g

## Truma iNet Box

### Central control unit for iNet-capable appliances

The Truma iNet Box is the core of the Truma iNet System. It links your iNet-capable heater or air conditioning system with your smartphone or tablet. Monitor and control your iNet-capable devices – which are marked as “Truma iNet ready” – conveniently via the app.



- **Convenient:** Allows remote control and monitoring of your iNet-capable heating and air conditioning systems via smartphone or tablet.
- **Easy to install:** Simply install and start up with the Truma App.
- **Versatile:** Can be controlled simultaneously from up to four mobile devices.
- **Exclusive:** Available from your Truma Partner.

### Technical data

- Power supply: 12 V/24 V
- Voltage range: min. 8 V, max. 30 V
- Average power consumption: 40 mA (12 V), 20 mA (24 V)
- SIM card type: Mini-SIM (25 x 15 mm)
- Interfaces: TIN Bus (2 x TIN1 replaceable, 1 x TIN2), GSM, Bluetooth
- Bluetooth: Class 2
- Dimensions: 147 x 96 x 40 mm (L x W x H)
- Weight: approx. 150 g

**Please note:** Advise your customers to check with their network provider whether the 2G network is still available. This is required for SMS communication with the Truma iNet Box.

# Cool air – distributed optimally



## Truma Aventa roof-mounted air conditioning system

A day at the beach: Sand between your toes, salt on your skin, the sun in your face. Make sure every day of your summer holiday has the perfect ending – in a caravan or van with the ideal temperature. Truma roof-mounted air conditioning systems cool the vehicle interior quietly, efficiently and very quickly. The air is also dehumidified, ensuring a pleasant indoor climate.

No matter whether you choose the compact or comfort Aventa models, both air conditioning systems can be installed easily on the roof of your vehicle. Thanks to the matching accessories, such as the **optional sealing frame**, Aventa models can be inserted very quickly into a skylight absolutely leak-proof. A levelling frame installation kit to complement the sealing frame is available especially for installation in vans.

Cool air flows throughout the entire interior via the **air distributor**. Adjust the four outlets individually and distribute the airflow evenly throughout your vehicle with no draughts. The air distributor is so flat that it takes up hardly any valuable space.



**5-year Truma parts warranty**  
Your Truma Partner provides a 5-year parts warranty for all Truma air conditioning systems.



**TÜV-certified**  
All Truma Aventa roof-mounted air conditioning systems are type-tested.

## Truma Aventa comfort

### Powerful cooling, efficient heating

Our fastest: The Aventa comfort can do more than just powerful cooling. During spring and autumn, you can also use the roof-mounted air conditioning system with integrated heat pump as a heater. And it's extremely energy-saving.



- **Powerful:** Cools the vehicle within a very short time.
- **Economical:** Very efficient in cooling and heating modes.
- **Convenient:** Remote control, programmable timer, LED dimmer lighting.
- **Exclusive:** Available from your Truma Partner.

### Technical data

- Cooling power: 2400 W
- Heating power: 1700 W
- Power consumption in cooling mode (230 V): 4.2 A
- Power consumption in heating mode (230 V): 3.7 A
- Dimensions of external unit: 1008 x 660 x 248 mm (L x W x H)
- Dimensions of air distributor: 670 x 523 x 46 mm (L x W x H)
- Dimensions of roof cut-out: 380 x 350 mm / 400 x 400 mm (L x W)
- Weight: 33 kg

iNet ready from serial number 24084022.

## Truma Aventa compact

### Fits in all vehicles from vans to motor homes

Our lightest: Aventa compact is designed to fit on the roof of any vehicle. In its performance class, it is also the lightest and quietest roof-mounted air conditioning system on the market. Of course, the cooling power is excellent.



- **Universal:** Even fits on small vehicle roofs.
- **Convenient:** Runs extremely quietly.
- **Smart:** Control the air conditioning system and ACC conveniently from the Truma App.
- **Exclusive:** Available from your Truma Partner.
- **Convenient:** The automatic climate control, together with the heater and Truma CP plus, ensures a constant feel-good temperature

### Technical data

- Cooling power: 1700 W
- Power consumption (230 V): 2.8 A
- Dimensions of external unit: 785 x 560 x 265 mm (L x W x H)
- Dimensions of air distributor: 556 x 496 x 46 mm (L x W x H)
- Dimensions of roof cut-out: 380 x 350 mm / 400 x 400 mm (L x W)
- Weight: 27.5 kg

## Truma Aventa compact plus

### Even more compact cooling power

Our best: With the same advantages as Aventa compact, Truma Aventa compact plus has even more cooling power. The vehicle reaches your desired temperature even faster.



### Technical data

- Cooling power: 2200 W
- Power consumption (230 V): 4.4 A
- Dimensions of external unit: 785 x 560 x 265 mm (L x W x H)
- Dimensions of air distributor: 556 x 496 x 46 mm (L x W x H)
- Dimensions of roof cut-out: 380 x 350 mm / 400 x 400 mm (L x W)
- Weight: 29.5 kg

# A pleasant climate in every corner

## Truma Saphir storage box air conditioning systems

A storage box air conditioning system allows you to **distribute the air individually** throughout your vehicle. Cool air is distributed flexibly through pipes – just the way you want it. Truma has a precisely coordinated **modular system** with which you can control the air volume and adjust the flow direction.

The **eco solution** distributes cool air through vents in the floor. Because of this, it is simple, inexpensive and quick to install. If **more comfort** is needed, direct the air in a cupboard upwards to distribute it evenly throughout the vehicle. With the **luxury option** you can specify that different areas are kept at exactly the temperature you want, such as for sleeping and living. This allows you to cool the vehicle consistently, quietly and with no draughts.

If quiet is still too loud for you, install sound mufflers in the cool airflow. Just one **sound muffler** installed in each cool air line reduces the noise of the airflow inside the vehicle by about 50 percent.

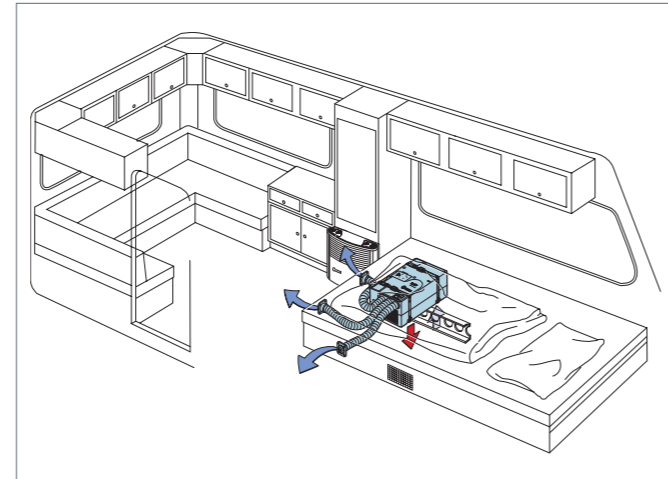

### Eco solution

Ideal for pre-cooling the vehicle. Simple, economical and quick to install with the **Saphir EasySet** (part no. 40090-44100).

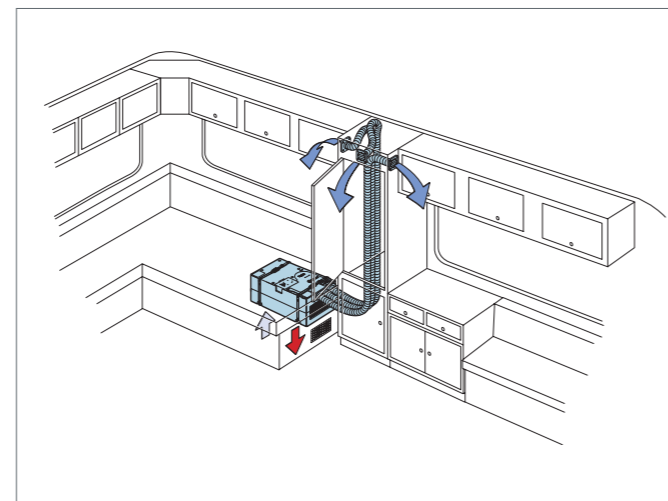

### Comfort solution

For even air distribution inside the vehicle. The air is routed upwards and cools both functionally and comfortably with no draughts. Up to 15 metres of cold air duct can be connected.



**5-year Truma parts warranty**  
Your Truma Partner provides a 5-year parts warranty for all Truma air conditioning systems.







## Truma Saphir compact

### Storage box system for smaller vehicles

Lightweight, low power consumption: The Saphir compact is ideal for small and medium-sized vehicles up to 5.5 metres long. The storage box system not only cools the air, but cleans and dehumidifies it at the same time.



- **Energy-saving:** Consumes very little power, which means that it can be used at most campsites throughout Europe.
- **Practical:** Cooling time can be programmed up to 15 hours in advance with the timer function.
- **Convenient:** Operated with Truma CP plus.

### Technical data

- Cooling power: 1800 W
- Power consumption (230 V): 2.8 A
- Dimensions: 560 x 400 x 290 mm (L x W x H)
- Weight: 20 kg

Truma CP plus compatible and iNet ready from serial number 23091001. In combination with a Combi CP plus heater, a "control panel cable coupling" (part no. 39050-00175) is essential between the air conditioning system and the heater.

## Truma Saphir comfort RC

### Cooling and heating with one device

Saphir comfort RC is designed to cool vehicles between 5.5 and up to around 6.5 metres long\*. The device can also be used as a heater with heat pump – thanks to the reversible cooling circulation system. With a heat output of 1700 W, the system generates pleasant warmth, especially during spring and autumn.



- **Efficient:** Cools particularly efficiently.
- **Compact:** The smallest in its class – installed in the seating box to save space and protect the device.
- **Convenient:** Adjust your individual feel-good temperature thanks to the automatic heating / cooling functions.

### Technical data

- Cooling power: 2400 W
- Heating power: 1700 W
- Power consumption in cooling mode (230 V): 4.2 A
- Power consumption in heating mode (230 V): 3.7 A
- Dimensions: 628 x 400 x 290 mm (L x W x H)
- Weight: 23.5 kg

\* For vehicle lengths of 6.5 m and over, we recommend installing two Saphir air conditioning systems.

# Always there for you



Information  
Anmeldung

## Truma Service

If you need assistance, we'll be glad to help – no matter where you are: we're always close by with our Truma mobile service technicians, in our Truma Service Workshop in Putzbrunn or with one of around 500 Service Partners throughout Europe and in the most important camping regions worldwide. With the right tools, original spare parts and, of course, more than 70 years of experience. Ensuring you can get things up and running again quickly.

## Truma Partners

Truma Partners have a wider range of services than other caravan dealers.

Truma Partners:

- provide a 5-year parts warranty on selected products
- offer you the complete range of Truma products
- are trained regularly
- are often also Service Partners.



[www.truma.com/dealersearch](http://www.truma.com/dealersearch)

## Truma Online

Keep up to date with our online portals and share your experiences with us. Become a subscriber, a fan or a follower.

### Website

From download centre to dealer search: our website [www.truma.com](http://www.truma.com) is your first port of call if you need help or want detailed information about Truma products.

### Newsletter

The newsletter contains information about new products, the company and much more delivered directly to your inbox.

### Truma App

In combination with the iNet Box, you can control your iNet-capable heater and air conditioning system easily with the Truma App while you're out and about.

### Social Media



<https://facebook.com/Truma.Fan>



<https://youtube.com/trumageraetetchnik>



<https://instagram.com/truma.official/>

## Your direct line to Truma

### Truma Service Center

E-mail: [service@truma.com](mailto:service@truma.com)

Phone: +49 (0)89 4617-2020

### Website

[www.truma.com/service](http://www.truma.com/service)

# Get the expert tips!

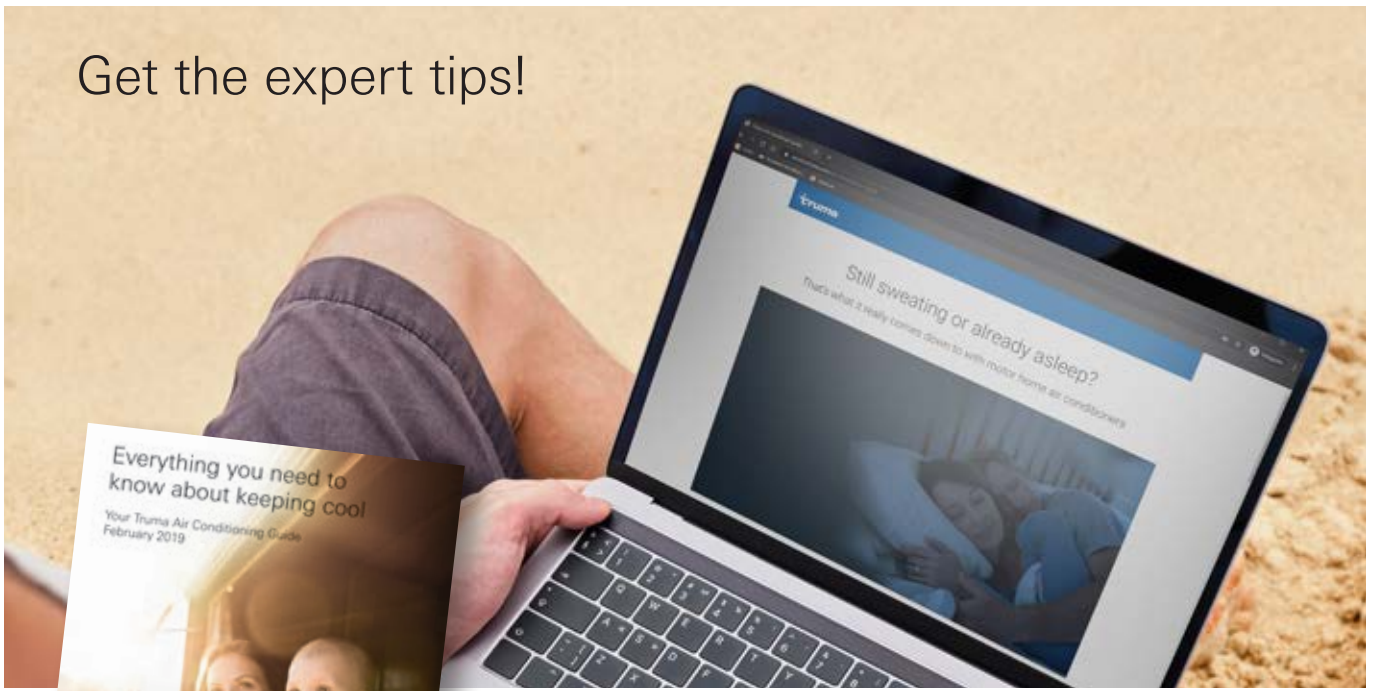

We've put together lots of useful information for you about climate comfort in motor homes and caravans. Our air conditioning guide will help you decide which air conditioning system is right for you, what to look out for when buying one and how Truma air conditioning systems measure up against the competition.



Download now at [www.truma.com/air-conditioner-guide](http://www.truma.com/air-conditioner-guide)



Your Truma Partner will be glad to assist you.



Printed on FSC®-certified Profibulk 1.1 paper. All raw materials originate from sustainably managed sources in accordance with EMAS registration, and are processed in a way that protects resources. For our environment. For you.

Truma Gerätetechnik GmbH & Co. KG  
Wernher-von-Braun-Straße 12  
85640 Putzbrunn  
Germany

[www.truma.com](http://www.truma.com)



More comfort on the move